

**HS-3510W/3512W/3514W**  
**JIVA Desktop POS**  
**User Manual**

***POSIFLEX***



**Package Contents**

- ✓ HS-3510W/3512W/3514W desktop POS (x 1)
- ✓ 24V/60W Power Adaptor (x 1)
- ✓ Power cord (x 1)
- ✓ 3-inch wide thermal paper roll (x 1)
- ✓ Paper separator for 2" thermal paper roll (x 1)
- ✓ Desktop mounting kit pack for HS-3510/3512 (x 1)  
(including 1 desktop mounting bracket,  
4 fixing screws, and 4 plastic anchors)
- ✓ Desktop mounting kit pack for HS-3514 (x 1)  
(including 1 bottom plate, 1 desktop mounting  
bracket, 4 fixing screws, and 4 plastic anchors)
- ✓ User manual (x 1)

**Product Feature**

- **Innovative All-in-one Terminal**  
This compact all-in-one 10"/12"/14" touch POS now comes with a detachable receipt printer for easy maintenance. Add an optional 2D barcode scanner while the printer is on board, making HS-3510W/3512W/3514W the most well-rounded all-in-one POS terminal in the market.
- **Integrated Design with Advanced Manageability**  
HS-series integrates the most widely used peripherals including 3" thermal printer, MSR, fingerprint sensor, 2D barcode scanner and 2nd customer display to support your daily POS operation. The detachable modularized design allows quick access to the components, enabling fast and easy service and upgrades.
- **Aesthetics**  
Dressed from head to toe in timeless black or white color, the only trend that never goes out of style, and with stylish touches added throughout, HS-series is not just a piece of machinery, it is an elegantly crafted piece of art that looks right at home in any store decoration.

15650900050 Ver. D0

<http://www.posiflex.com>

## Views of HS-3510W/3512W/3514W

### Front View

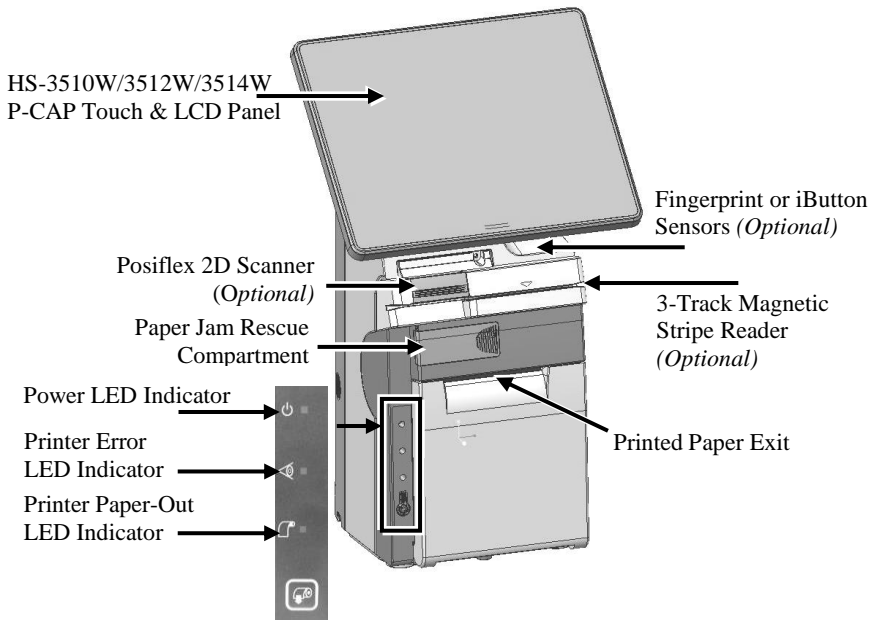

### Rear View

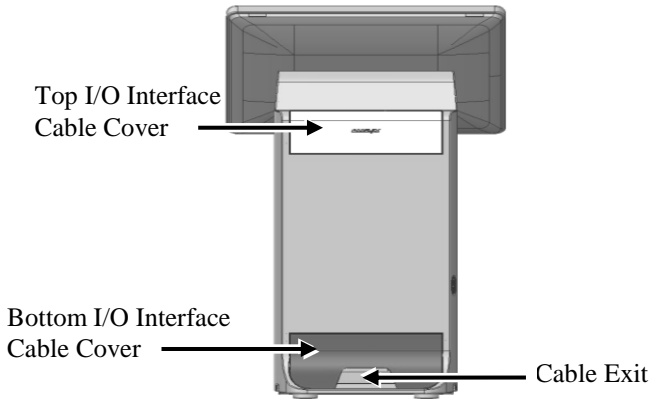

Left Side View

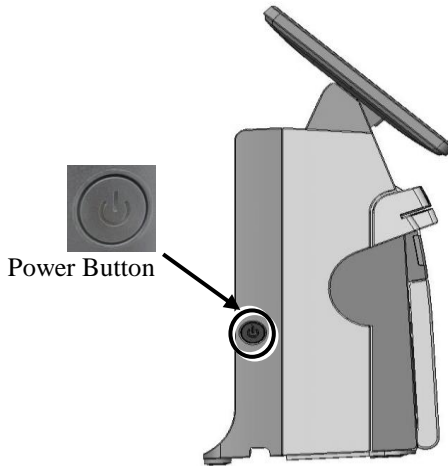

Right Side View

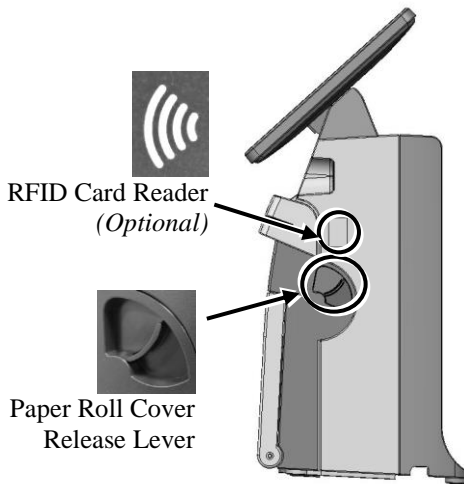

Bottom View

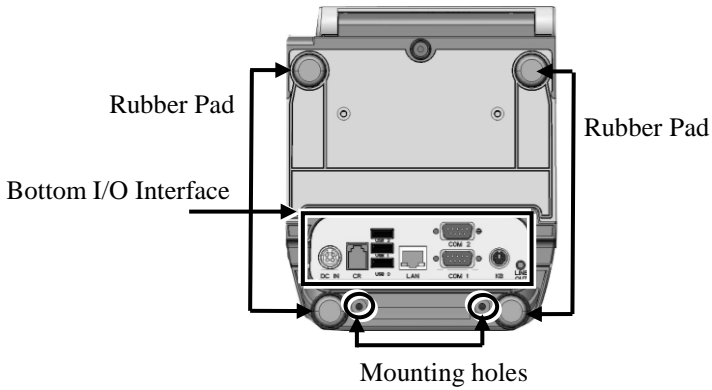

**Views of I/O Interface of HS-3510W/3512W/3514W**

Top I/O Interface

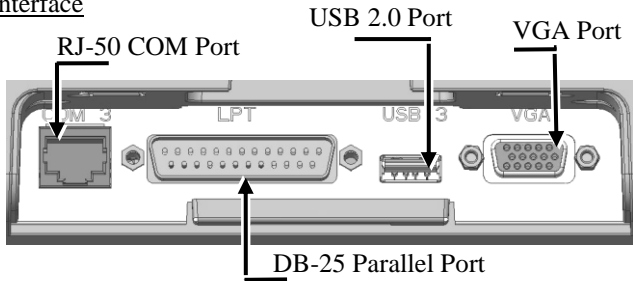

Bottom I/O Interface

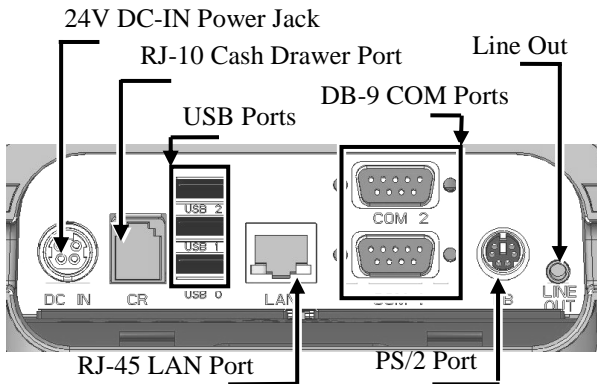

## Connecting Power Adapter

Please refer to the following instructions on how to connect power adapter to HS-3510W/3512W/3514W and to organize your cables.

1. Lay your desktop POS on a level surface with its touch screen facing down as shown in the figure.



2. Hold the bottom I/O interface cover with your thumb and forefinger, and then gently pull the cover outwards to remove the cover.



3. Connect power adapter and I/O cables to the bottom I/O interface.



4. Have the cover join to the wedge portions of the bottom I/O interface.

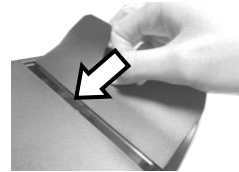

5. Before pushing the cover back into place, neatly thread the cables through the cable exit.



6. Press down the cover to close the bottom I/O interface chamber.

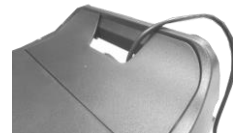

## Loading 2” or 3” Paper Rolls

Before operating the printer, please follow the below steps to load a paper roll.

1. To open the paper roll cover, push down the paper roll cover release lever in the direction shown in the figure.



2. Before installing **2-inch paper roll** in the thermal printer, place paper separator in the paper roll compartment by following the instructions below. If you are using 3” paper roll for the printer, please skip to next step.

- 2.1. Hold the separator with the sharp-pointed side down.

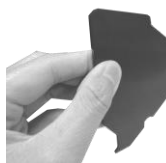

- 2.2. Push the sharp-pointed part of paper separator into the slot on the bottom of the paper roll compartment.



- 2.3. Slide another side of paper separator into the slot on the top of the paper roll compartment.



- 2.4. Drop 2-inch paper roll inside the paper roll compartment.



3. To load the thermal printer with **the 3-inch paper roll**, just drop the thermal paper roll inside the paper roll compartment of the printer as illustrated in the figure.



4. Unroll the thermal paper and drag the loose end of the paper till it extends towards the paper cutter.

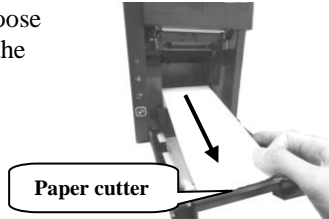

5. Make sure the loose end sticks out of the opening of the paper roll compartment. Then, close the paper roll cover by pushing it back at the center of the top side of the cover with a click sound.



6. Make sure the paper roll is well loaded with the end of the paper sticking out as shown in the figure.



**To avoid paper jam or other printing errors, do NOT press the paper roll cover release lever during printing.**

## Troubleshooting Paper Jams

When it comes to the common printing problems, it is inevitable that you might encounter the issue of paper jams at some point. The following steps are provided to assist you in fixing the problem. Before proceeding, make sure that your POS terminal is properly shut down.

1. Open the paper jams rescue compartment by sliding the cover in the direction shown by the arrow.



2. In the paper jams rescue compartment, find the adjustment wheel, which mainly allows you to manually adjust the cutting position of the cutter blade.

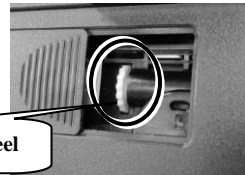

Adjustment wheel

3. Keep rotating the wheel until the cutter blade is completely retracted.

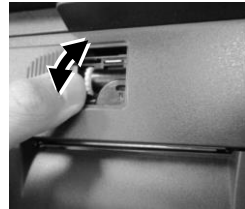

4. Observe the cutter position through the paper exit slot to ensure the cutter blade moves upward to the retracted position.

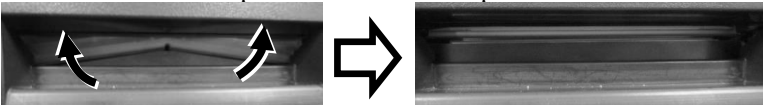

5. Gently push down paper roll cover release lever to open the paper roll cover. If the cover is still stuck, please repeat Step 3 and Step 4.



6. Remove the jammed paper, reinstall the paper roll, and then close the paper roll cover firmly.



## Replacing POS Receipt Printer Module

HS-3510W/3512W/3514W offers a quick solution to help you to replace POS receipt printer module when there is a need. Please go through the steps described below to achieve the purpose. Before proceeding the procedure, please ensure that the terminal is completely shut down.

1. After laying POS terminal on a flat surface with its bottom facing towards you, remove the screw shown by the arrow.
2. Position the terminal with its screen facing toward you, and then push down the paper roll cover release lever to open the paper roll cover,
3. Inside the paper roll compartment, remove the two screws indicated by the arrows.
4. While supporting the terminal with one hand, grab the right-hand side of the terminal and then pull the front cover towards you with force to separate the printer module from the rear case of HS-series
5. From the left-hand side of the terminal, remove the front cove from the rear case.



6. Disconnect all the cables indicated in the figure.

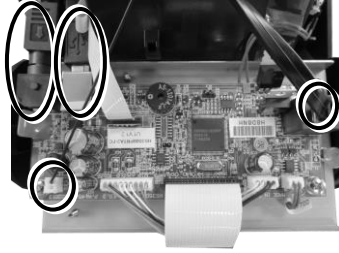

7. Take the new printer module which you wish to replace with, and then connect the cables to the printer control board as indicated in the following figures.

- 7.1 Connect the CR cable to CR port on the control board.

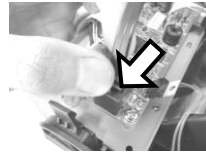

- 7.2 Insert the cable to the port for printer signal on the control board.

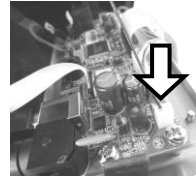

- 7.3 Attach the USB cable to Type-B USB port on the control board.



- 7.4 Plug the cable to DC-IN power jack on the control board.



- Carefully support the printer module with both of your hands and then push it back into the rear case of HS-series terminals.

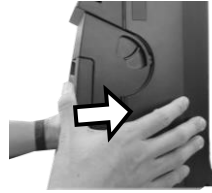

- After ensuring the front cover is well attached to the rear case, insert the two screws back into the screw holes inside the compartment, secure them, and then close the cover.



- Insert the screw which you removed in step 1 to the screw hole at the bottom, and then fasten it properly, as the figure shows.

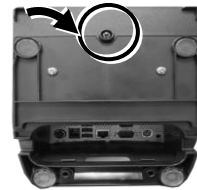

### **Mounting the POS onto a Table**

This section will describe two alternative solutions to help you fix the POS firmly onto a table in preventing your POS system from being rocked, tipped or tilted accidentally.

#### **Using bottom plate (for HS-3514 only)**

Please be informed the bottom plate is available for HS-3514 models, but an optional item for HS-3510/3512 users. Please follow the steps below to install the bottom plate for HS-3514.

- Take the bottom plate with the mounting bracket out of the package, and place it with its screw holes on the top in your preferred position.
- 

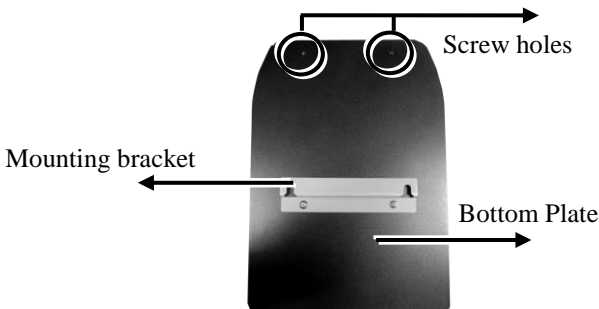

3. Support your POS terminal with its screen facing towards you. Then, align the two screw bolts on the bottom of the POS with the rail slots of the mounting bracket.



4. Push the POS backwards along the rail slots of the bracket until the terminal is locked into place.

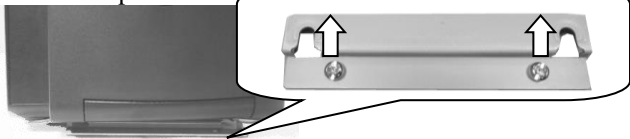

5. After inserting another two screws into the two mounting holes located on the rear of the POS, fasten them to fix the POS terminal to the bottom plate.



### Using desktop-mounting kits

Please follow the steps below to install desktop-mounting kits.

- 1.

**For HS-3510/3512 users,** take the mounting bracket out of desktop-mounting kits.



**For HS-3514 users,** please first release the mounting bracket from the bottom plate by removing two screws as shown in the figure.

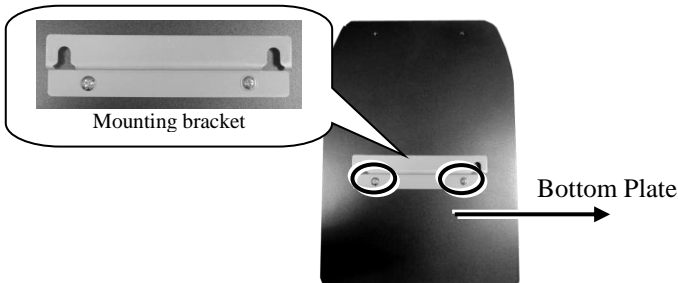

2. After placing the mounting bracket in your preferred mounting position, use the screw holes of the mounting bracket to drill two holes on the surface. Each hole has to be at least  $\frac{1}{4}$ " or 6.25 mm diameter and  $1\frac{3}{8}$ " or 35mm in depth.

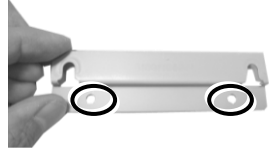

3. Insert two plastic anchors into the holes you drilled in step 2 and use a hammer to tap the plastic anchors into the drilled holes.



4. After well attaching two screw holes of the mounting bracket to the plastic anchors, insert two self-tapping screws into the plastic anchors through the mounting bracket and then secure the bracket.



5. Support your POS terminal with its screen facing towards you. then, align the two screw bolts on the bottom of the POS with the rail slots of the mounting bracket.

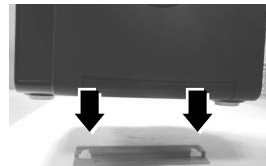

6. Push the POS backward along the rail slots of the bracket until the terminal is locked into place.

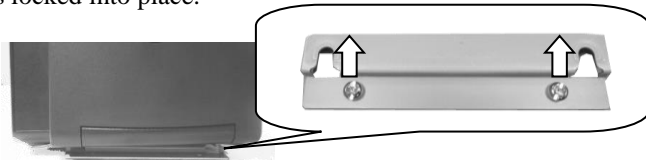

7. To completely mount the desktop POS onto the table, please follow the steps below.

7.1 Use the two mounting holes located on the rear of the POS to drill another two holes on the same surface. Each hole also has to be at least  $\frac{1}{4}$ " or 6.25 mm diameter and  $1\frac{3}{8}$ " or 35mm in depth.



7.2 Push the POS in the direction shown by the arrow to remove it from the mounting bracket.

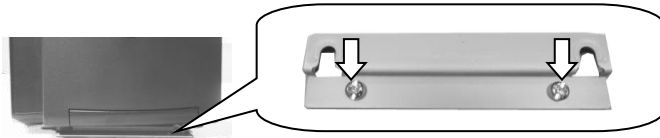

7.3 After pushing two plastic anchors into the drilled holes, tap the plastic anchors into the drilled holes with a hammer.



7.4 Refer Step 6 to mount the POS to the bracket.

7.5 Apply two self-tapping screws through the mounting holes into the two plastic anchors. Then, fasten the screws to completely lock the POS onto the table.



### **Installing a Customer Display to HS-3510W/3512W/3514W**

HS-3510W/3512W/3514W also allows you to additionally install a customer display to expand its functionality. Based on the model of the second display, the step-by-step instructions are provided in its own user guide to help you mount it onto your POS system. Please refer to the relevant user manual for detailed information.

### **Installing an Operating System**

You are highly advised NOT to install an operating system on HS-3510W/3512W/3514W without professional instructions. Not only might the careless handling during installation cause irreversible damage to your system, but also the improper installation likely leads to system malfunction or failure. Please contact with your dealers about the issues of operation system installation.

### **Performing System Recovery**

For HS-3510W/3512W/3514W with preloaded operating systems, Please be advised to contact your service center for further assistance with system recovery. You are NOT encouraged to recover your system without the help of the system integrators.

## Powering ON/OFF the HS-3510W/3512W/3514W

### Power ON HS-3510W/3512W/3514W

To power on the POS, gently press and hold down the power button for at least 1 second till the Power LED indicator turns solid blue, and then release the button.

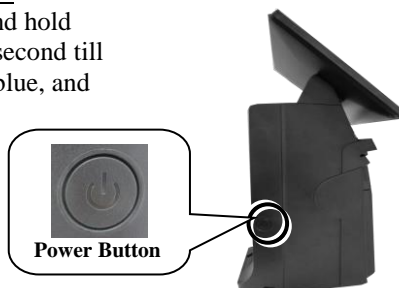

### Power OFF HS-3510W/3512W/3514W

For HS-3510W/3512W/3514W which is preloaded with Windows OS, please carefully go through the sequences described below to properly shut down the system:

1. Right click on **Start button** on the taskbar.
2. In the pop-up menu, select **Shut down or sign out** > **Shut down** to completely power down the POS system.

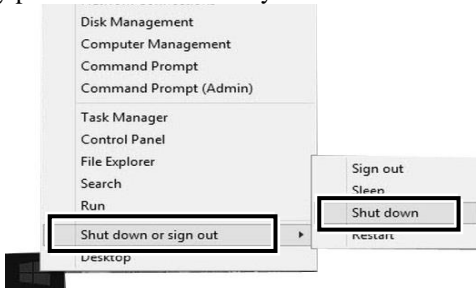

However, it is likely that POS terminals cannot restart or shut down normally due to the unexpected reasons. In such a case, you should initiate a shutdown by keeping holding down the power button more than 10 seconds.



## Operating the Magnetic Stripe Reader (Optional)

To have the magnetic stripe reader of HS-3510W/3512W/3514W work properly, you must bear in mind the following tips while swiping your MSR cards through the reader.

1. Make sure to swipe your card with the side of magnetic stripe facing up.
2. Make sure to swipe your card along the track of the reader from left to right or from right to left in the direction shown below.

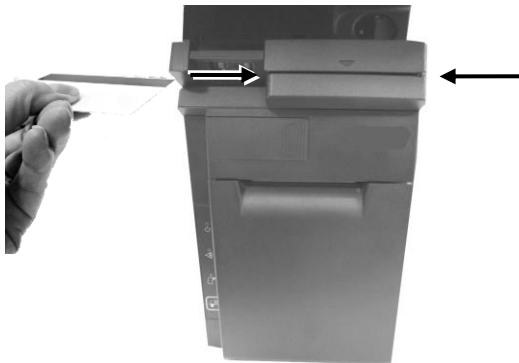

## Using the RFID Card Reader (Optional)

To retrieve data through the RFID card reader, tap your Mifare card against the RFID reader as shown below.



### Scanning Barcodes with Posiflex 2D Scanner (Optional)

The integrated Posiflex 2D Scanner is another prominent feature of HS-3510W/3512W/3514W. With its hand-free design, it offers a more convenient solution for users to read 1D/2D barcodes and then transmitted scanned data to the terminal for further processing, which greatly increases your working efficiency. By default, the scanner is set to **Auto Trigger** operational mode.

Also, to adjust the scanning angle of the scanner, you may tilt the scanner up and down as indicated in the figure below.

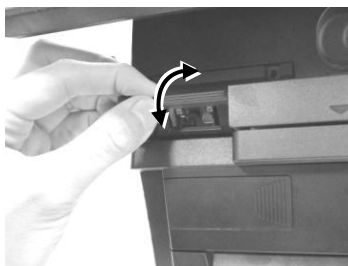

### Using Fingerprint or iButton Sensors (Optional)

As for access control to your computer, two optional identification mechanisms are provided and integrated in HS-3510W/3512W/3514W: The fingerprint and iButton sensors. Either will work to verify an individual's identity.

In order to allow the fingerprint sensor to function normally, you have to register your own finger first using *Fingerprint Recognition Tool* which is pre-installed and accessible on your desktop of your system.

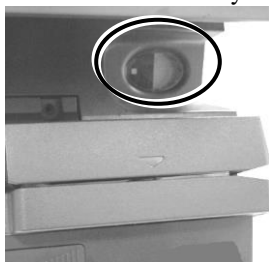

**Fingerprint Sensor**



**iButton Sensor**

## Status LED Indicator

After HS-3510W/3512W/3514W is powered on, it is significant to observe the status of LED indicators anytime to ensure your system functions normally. More importantly, knowing how to interpret the status indicators enables you to perform basic troubleshooting more efficiently. The below chart is thus provided to enumerate all the possible indicator lights with their meanings for your reference.

LED	Status	Description
POWER LED	Solid orange	System standby
	Solid blue	System ON
Error LED	Solid red	Cover open
	Flashing red	Operating temperature of thermal head is high
Paper-out LED	Solid red	Out of Paper

## Adjusting LCD Monitor for a Better Viewing Angle

For an optimal viewing angle, please tilt the LCD monitor up and down in the directions shown by the arrow in the below figure. Please be advised not to touch LCD panel while setting up the tilt angle for HS-3510W/3512W/3514W.



## Specifications

	HS-3510W	HS-3512W	HS-3514W
CPU	Intel Bay Trail J1900 CPU		
Memory	DDR3L-1333 FSB, 1 x SO-DIMM socket, 8GB Max.		
Storage Device	2 x SATA connector ( 1 x 2.5" SSD + 1 x 1" SSD) or 1 x eMMC connector (for Win8.1 & Win10 only)		
Power Supply	24V/60W		
Display	9.7" 1024 x 768 LCD Panel	12.1" 1024 x 768 LCD panel	14" 1366 x 768 LCD panel
Operating System	POSReady 7/Windows 8.1/ Windows 10 IoT		
Touch Screen	Bezel-free P-CAP touch		
Serial Port	2 x DB9 Port (on bottom I/O plate) 1 x RJ50 Port (on the top I/O plate)		
Parallel Port	1		
CR Port	1 Port controlling 2 CR (24V drive)		
VGA Port	D-SUB 15-pin , with 12V power for Posiflex LCD monitors		
Standard USB Port	4 x USB 2.0 ports (one on the top I/O plate and the other three on the bottom I/O plate)		
Audio Port	Line Out		
DC-In Jack	1 x 24V DC-In (on bottom I/O plate)		
Ethernet Port	1 x 10/100/1000 Mb		
LED Indicator	Power ON/ standby, bi-color LED indicators Ethernet link LED indicator on Ethernet connector Printer error & paper-out LED indicators		
Extension Slot	Mini-PCIe slot		
Optional Items	MSR, WiFi, RFID Reader, Fingerprint or iButton Sensors, 2D Scanner Sensor, 3G Module		
<b>Thermal printer with auto-cutter</b>			
Printer speed	250 mm/sec max.		
Paper size	3" thermal paper or 2" thermal paper with 2" paper separator		
<b>Posiflex 2D Scanner</b>			
Focal distance	Minimum	8 cm	
	Maximum	14 cm	
View Angel	Horizontal	approx. 40.6°	
	Vertical	approx. 26.4°	
Supported Symbology	UPC, EAN, Code 39, Codabar, Interleaved 2 of 5, Matrix 2 of 5, POSTNET, MSI/Plessey, UK/Plessey, Code 128,GS1- Databar, GS1-Databar Limited, GS1-Databar Expanded, QR Code, PDF417		